

Company Profile - TABLE OF CONTENTS

S.NO.	DESCRIPTION	PAGE NO.
	ABOUT NASSACO	
1.	Company Introduction	2
2.	Organization Information	3-5
3.	Organization Chart	6
4.	Company Official Documents (CR, Chamber, Vat Certificate, Etc.)	7
5.	Safety Policy	8
6.	Quality Policy	9
7.	ISO 9001:2015 Certificates	10-12
	JV PARTNERS	
8.	CJI General Services(Electromechanical)-Philippines	13
	CONSULTANT PARTNERS	
9.	Plexus (Instrumentation/SCADA) - Portugal	14-16
	CAPABILITIES	
10.	Scaffolding Works	17
11.	Electricity Works	18-19
12.	Sand Blasting and Painting	20
13.	Instrumentation, Automation and SCADA	21
14.	Industrial Insulation Services	22
15.	Pipe Repair Services	23
16.	Skilled Manpower Supply	24-25
17.	Telecommunication works (Fiber-optic)	26
18.	Civil Structural Design Services	27-29
19.	General Civil Works	30
20.	Roads and Blueprints	31
21.	Security fencing grille Supply and Install, remove, replace, modify	32
22.	Earth Moving Equipment Supply Services	33
23.	Industrial Equipment Rental Services	34
24.	Information Technology	35
25.	Safety Materials	36
	FACILITIES AND RESOURCES	
26.	Office, Workshops, Warehouses, Laydown Yard, Camps...etc.	37-40
27.	Location map-1 – Corporate Head office, Laydown Yards, Warehouses, Camps – Umm Al Sahek	41
28.	Location map-2 – Laydown Yards, Warehouses, Camps – Al Ahsa	42
29.	Vehicles / Equipment / Machineries / Devices	43-45
30.	Manpower	46-47
	REFERENCE PROJECTS	
31.	Completed & On-going projects	48-40
32.	NASSACO Certificates from Clients	51

COMPANY INTRODUCTION

The purpose of this letter is to introduce our company “NASSACO” (a 100% Saudi owned company) which has been a favorite since 1997 in the fields of Industrial Services – Fabrication, Scaffolding, Industrial and Residential Electric Systems Installation(SEC approved),cables tested, solution solar energy systems ,Sandblasting/Painting, Instrumentation, Automation and SCADA, Industrial Insulation Services, Welding, Erection, Pipe Repair Services, Skilled Manpower Supply with complete application of Saudi Aramco, SABIC and SEC approved standards,

Telecommunication works (Fibber-optic) Engineering, Design& Project Management Services, General Civil Works, Building Construction and maintenance, Carrying out water, sewage and rainwater network ,Industrial Equipment Rental, Heavy and Light equipment rental, Security fencing grille , Networks, surveillance cameras, Information Technology Networks Enterprise Software Development Web design Security monitoring systems, , Security fencing grille , Networks, surveillance cameras , Safety Materials .

We have catered our wide-range of quality services and products to Oil & gas, Petrochemical, Power plants and process industries such as Saudi Aramco, SEC, STC, SABIC companies, SATORP, SADARA and various other clients in private sector in the past and have had a good working relationship with all of them,

With no complaints from our clients. As a company, we offer you services that are of the highest standard and at extremely competitive rates.

Recently, NASSACO have established joint venture with foreign contractor partners having the expertise in industrial, oil and gas projects execution. CJI PHILIPPINES and MARS INDUSTRIAL CONTRACTING is mainly having the expertise in mechanical, pipe, steel fabrication, erection and revamp for oil refineries, power plant, petrochemical plant, and environmental facilities.

Enclosed with this letter is a comprehensive profile that enlists all the different products and services that you can make use of.

We would like to thank you for the time that you have taken in order to go through this letter and the profile.

Please feel free to contact us in case you need to utilize any of the products and services that our company provides. We guarantee you complete satisfaction.

Please visit our website www.nassaco.com for more information about our services.

Thanking you,

Nassir S. Al Hyder & Partner Co. (NASSACO)

P O Box: 476 | Safwa 31941

Email: info@nassaco.com

Mobile: 050 2824111

Tel: 013 668 0775 Fax: 013 667 1246

www.nassaco.com

ORGANIZATION INFORMATION:

Corporate Head office:		Safwa Umm Al Sahek	
GPS Coordinates	26.6272887,49.877377	Post Box	476, Safwa-31941
Telephone	+966-13-6680775	Telephone	+966-13-66804707
Fax	+966-13-667 1246	E-mail	info@nassaco.com
Website	www.nassaco.com	CR. No	2063605934

SL.	NAME	TITLE	EMAIL	MOBILE
1	NASSIR AL-HYDER	MANAGING DIRECTOR	Nassir.haider@gmail.com	00966 50 584 5880
2	MOHAMMED AL SHEBAMI	MD Assistant	shebami@nassaco.com	00966 56 190 4656
3	AHMED TAIB	BUSINESS DE. MANAGER	taib@nassaco.com	00966 55 888 2532
4	AFTAB QURESHI	OPERATIONS MANAGER	aftab@nassaco.com	00966 55 649 9243
5	RABIE SHARIEF	ACCOUNTS MANAGER	rabie@nassaco.com	00966 56 880 3867
6	SIYADU KABEER	COMMERCIAL MANAGER	siyad@nassaco.com	00966 50 685 5193
7	ALI SALEH ALI AL HARETH	HR & ADMIN MANAGER	ali@nassaco.com	00966 56 190 2923
8	MD TAJ ALI	MATERIALS PLANNING MANAGER	mpd@nassaco.com	00966 56 190 2621
9	AMEEN AL – GARAWI	LOGISTICS MANAGER	amen@nassaco.com	00966 54 560 9022
10	NASSACO	HEAD OFFICE	info@nassaco.com	00966 13 668 0775

Communication of the Marketing Department

SL.	NAME	TITLE	EMAIL	MOBILE
1	AHMED TAIB	BUSINESS DE. MANAGER	taib@nassaco.com	00966 55 888 2532
2	AFTAB QURESHI	OPERATIONS MANAGER	aftab@nassaco.com	00966 55 649 9243
3	SIYADU KABEER	COMMERCIAL MANAGER	siyad@nassaco.com	00966 50 685 5193
4	www.nassaco.com	00966 50 388 9697	info@nassaco.com	00966 50 282 4111



OUR VENDOR NUMBER WITH MAJOR COMPANIES:

	10025893		14235		20686
	5000968		10941		13374
	502721		3694		101064
	20281		AN01580600020		AN01448953035
					
				www.nassaco.com	
					

NASSACOGROUP



Majd Al Khaleej

MajdAlkhaleej trading & industrial services (GULF GLORY) is genuinely a trading company that deals many commodities related to industries of oil and gas, petrochemical, power plants and desalination plants. MajdAlkhaleej is an approved and active vendor with Saudi Aramco, SEC and SABIC and many other clients. MajdAlkhaleej is an exclusive agent and supported by many approved manufacturers around the world.



ORBIT AL JAZEERA CO

ORBIT AL JAZEERA CO. Company works in the field of heavy and light equipment rental and other industrial services



Earth Moving EST.

Earth moving is an organization working in the civil of infrastructure and equipment rental

ORGANIZATION CHART

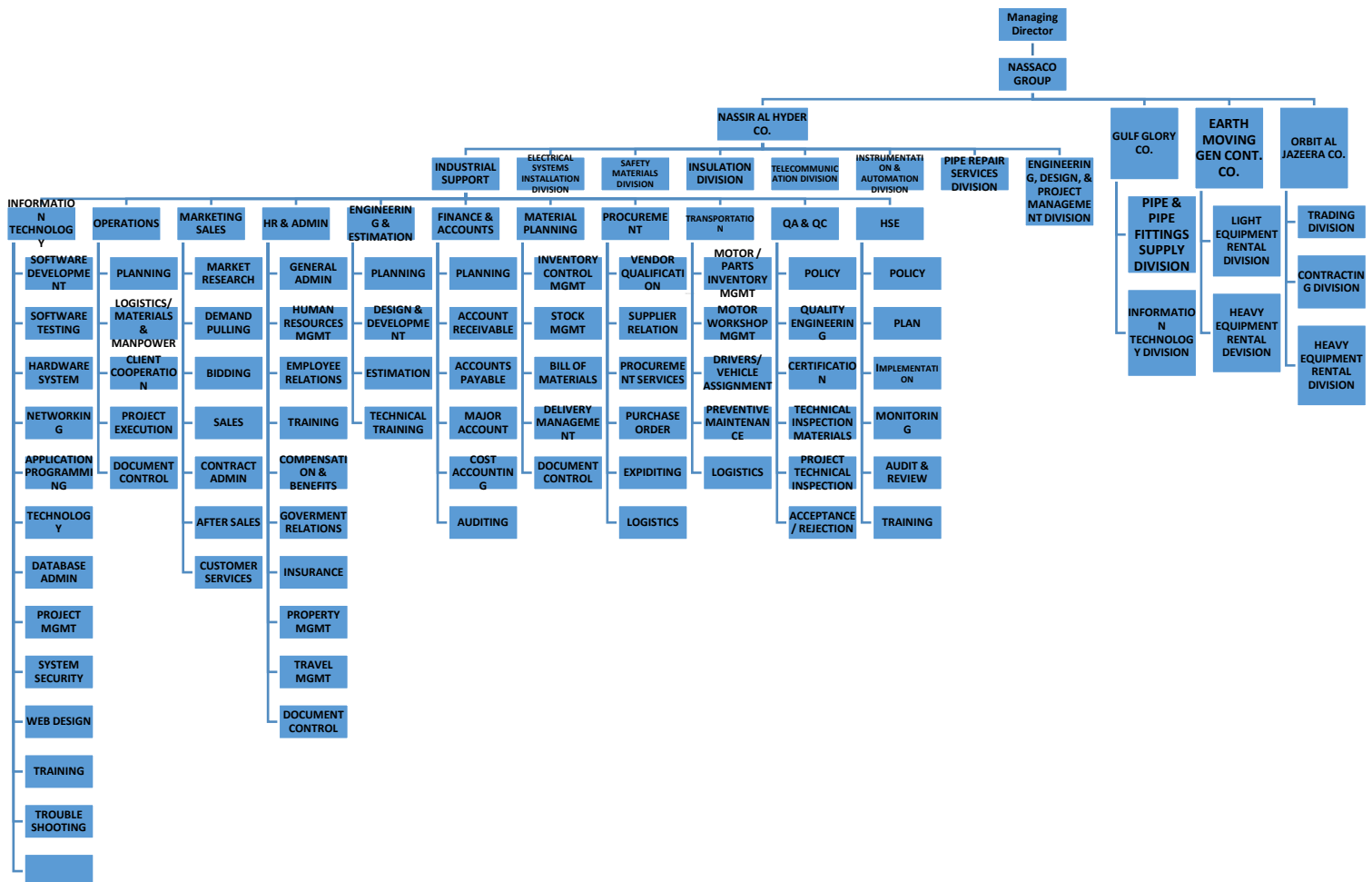

Company Official Documents

رؤية 2030
المملكة العربية السعودية
KINGDOM OF SAUDI ARABIA

وزارة التجارة
Ministry of Commerce
شهادة تسجيل الشركة

الرقم الموحد للمنشأة: ٧٠٠١٣٨٣٠٤٦
النوع: ذات مسئولية محدودة
النوع: سعودي
مدة الشركة: ٢٠ سنة
تبدأ من: ١٤٣٧/٠٦/٢٩ هـ وتنتهي في: ١٤٥٧/٠٦/٢٨ هـ
مركزها الرئيسي: ٦٦٠٢ شارع الحزم، حي الحزم، ٤١٦٧
ص ب: ٤٧٦ الرمز البريدي: ٣٢٧١٤ هاتف: ١١٠٠٠٠٠٠٠
النشاط: للإطلاع على بيانات الأنشطة الرجاء مسح الرمز التجاري
رأس المال: ٢٠٠٠٠٠٠ ريال سعودي
المديرين: ١ ناصر بن سالم بن دلامه آل حيدر

سلطات المدير/المديرين: حسب ما نص عليه عقد الشركة

يشهد مكتب السجل التجاري بمدينة: صفوي بأنه تم تسجيل الشركة المذكورة أعلاه بمدينة: صفوي
وتنتهي صلاحية الشهادة من: ١٤٤٦/٠٦/٢٧ بموجب الإيصال رقم: ١٠٠٧٨٦٩٣٨ وتاريخ: ١٤٤٣/٠٥/٢٩ هـ

مدير السجل التجاري للشركات: **عبد المحسن بن إبراهيم الحماد**
التوقيع: 

To verify the information of this certificate visit <http://v.mci.gov.sa> على صحة هذه الشهادة بالدخول على

شهادة تصنيف المقاولين
رقم: ٢٢٨٦٢
اسم المقاول: شركة ناصر سالم آل حيدر وشريكة للمقاولات العامة
نوع الملكية: شركة تضامنية
رقم السجل التجاري: ٢٠٦٣٦٠٥٩٣٤
رقم الإيصال: ٣١٩٤١
مجال التصنيف:
البيانات:
الطرق:
الاعمال الكهربائية:
(تصنيف في ثلاثة مجالات فقط)

رقم: ١١١١٦
التاريخ: ١٤٤١/٠٣/٢٧
رقم الملف: ١١٠٨٦

مصدر: صفوي
هاتف: ٠١٣٦٩٨٠٨٦

تاريخ: ١٤٤٠/٠١/٢٠
أقراص: ٠١٣٦٦٧١٤٤

الدرجة:
العمارة:
المرحلة:

وكيل الوزارة لشؤون تصنيف المقاولين المكلف
م/ فيصل بن حسين الصقار

تاريخ الشهادة بتاريخ: ١٤٤١/٠٣/٢٧ هـ

ملاحظة هامة جداً: يجب متابعة ظهور على الأمر في كل حالة ولا تُسند أو تدبر في هذه الشهادة بعدها

شهادة التسجيل في شريحة القيمة المضافة
VAT registration certificate

مكتب الهيئة العامة للزكاة والدخل يأنشئ هذه الشهادة للشركات المسجلة في شريحة القيمة المضافة في المملكة العربية السعودية وفقاً للمادة ١١٠ من نظام ضريبة القيمة المضافة الصادر بالمرسوم الملكي رقم ٤٧٦/٢٠١٥هـ وتاريخ ١٤٣٦/٠٦/٢٩هـ.

معلومات المالك الرئيسي:
الاسم: ناصر بن سالم آل حيدر
مستودع البريد: ٢١٦٤١
الهاتف: ٠١٣٦٩٨٠٨٦

الهيئة العامة للزكاة والدخل
مكتب الترخيص حرسه من التزوير، يرجى التحقق من التوقيع

شهادة الانضمام - Membership Certificate

الرقم الموحد للمنشأة: 7001383046
الدرجة: الأول
تاريخ الإصدار: 13/7/1443
التشيد: العرفة التجارية المنصاحة بالمنطقة الشرفية بأن
(شركة ناصر سالم آل حيدر وشريكة للمقاولات العامة (شركة شخص واحد)
رقم الإيصال: 239400
مشاركة في العرفة منذ: 27/06/1439
ويتبقى سريان هذه الشهادة في: 27/06/1446
رقم راس توريد: 31941

The Unified Number: 7001383046
Classification: First
Date of Issue: 14/02/2022
Asharqia Chamber Certifies that:
NASSIR S. AL-HYDER & PARTNERS TGEN. CONT. CO
Membership No: 239400
Registered with Chamber since: 13/05/2018 and
the certificate expires on: 28/12/2024
476 راس توريد: 31941

يمكنك التحقق من صحة هذه الشهادة
<https://www.chamber.org.sa/VerifyCert>

شهادة عضوية مقاول
SCA
Saudi Contractors Authority

تاريخ التسجيل: Jun, 2021

تاريخ انتهاء العضوية: June 9, 2022

شركة ناصر سالم آل حيدر وشريكة للمقاولات العامة
رقم العضوية: 100005980

تاريخ انتهاء العضوية: June 9, 2022

يمكنك التحقق من صحة هذه الشهادة عن طريق زيارة الرتبة: <https://www.sca.gov.sa>

م. ثابت مبارك آل سويد
رئيس مجلس إدارة الجمعية
رقم الهاتف: 996020000968
البريد الإلكتروني: info@sca.gov.sa
SCA, S-3

SAFETY POLICY



It is the policy of NASSACO to regard the promotion of Health, Safety and Environment measure as a mutual objective for management and employees at all levels. It is therefore, the company's policy to do all that is reasonable to prevent personal injury and damage to property and to protect everyone from foreseeable work hazards including other persons who may be affected by the company's activities.

In particular, the company has a responsibility:

- To provide and maintain safe and healthy working conditions
- To provide trainings and instructions to enable employees to perform their work safely and efficiently
- To make available all necessary safety devices and personal protective equipment and to supervise their use
- To maintain a constant and continuing health, safety and environment issues that are applicable to the company's activities, in particular, by consulting and involving employees wherever possible

Employees have a duty to cooperate in the operation of this policy:

- By working safety and efficiently
- By using the protective equipment provided and by meeting statutory obligations
- By reporting incident that have led or may lead to injury, damage or loss
- By adhering to company procedures and system of work

The company sees this policy as a vital element of our day to day operations and our success in future. We shall therefore continually pursue this policy through strong management commitment to health, safety and environmental issues.

QUALITY POLICY



Nassaco is committed to comply with the requirement of the customers and to continually improve the effectiveness of the Quality Management System. It must be clearly understood that this Quality Policy, Quality Manual and associated Operating Procedure and systems are mandatory on all staff.

The management of Nassaco is fully committed to the Document Quality Management System in the principle of providing services of consistently high quality in safe manner to the complete satisfaction of its Customer. The operation of the Quality System is subject to continuous review at the highest management level, to ensure that the established standards are maintained and improved wherever necessary.

NASSACO has introduced system that will set and review measurable quality objectives. The Management actively encourages all personnel commitment to Quality and to accept the responsibility for the achievement of the highest standards of workmanship, to enhance the reputation of the company.

ISO Certificates



Certificate of Registration

Certificate No: 190212036621

This is to Certify that the Occupational Health and Safety Management System of
Nassir S. Al Hyder and Partner Company For General Contracting
 P.O Box 476, Umm Al Sahik, Safwa 31941 - Kingdom of Saudi Arabia
has been assessed and found to be in accordance with the requirements of
ISO 45001:2018
This Certificate is valid for the following scope

“Provide (Civil, Electrical & Mechanical) Services Related to Construction and Maintenance of Buildings, Roads, Water & Sewage System & Industrial Facilities, Design & Installation of Scaffolding Systems in Public and Industrial Sector, Provide Services of Industrial Blasting & Coating System, Trading and Rental of Heavy & Earth Moving Equipment’s”

(IAF Group- 28 & 29)

Initial Registration Date	12 th Feb. 2019	Current Issue Date	13 th Feb. 2023
1 st Surveillance on or before	Completed	Valid Until	11 th Feb. 2024
2 nd Surveillance on or before	12 th Jan. 2024	Issue No.	02
		Revision	01

Certification Cycle of this certificate is three (3) years from the issue date and validity of the certificate shall be subject to the successfully completion of the surveillance audit as mentioned above, current status of the certificate can be verified on
i.e. www.isoindia.org & www.iafcertsearch.org



UAF
CB-MS-2208





Pragyesh Singh
 TNV Certification Pvt Ltd
 CIN: U74900UP2011PTC046719
Accredited by United Accreditation Foundation (UAF)

Accreditation Board Add: United Accreditation Foundation Inc, 400 North Center Dr Ste 202, Norfolk, Va 23502, United States of America

Certification Body Add. H.O.: TNV House, 537-B/187-B Amber Vihar, Lucknow-20, India. Mail: info@isoindia.org

*Validity of the certificate is subject to continued compliance of the management system standard and successful completion of audit as planned by TNV from time to time. Further clarification regarding the scope of this certificate and the applicability of standard may be obtained by consulting the organisation. This certificate remains property of the TNV and must be returned on request. For surveillance details, please visit at www.isoindia.org. Registered Office: TNV House, 537-B/187-B Amber Vihar, Lucknow-20, UP, India.



Certificate of Registration

Certificate No: 170121016622

This is to Certify that the Quality Management System of
Nassir S. Al Hyder and Partner Company For General Contracting
P.O Box 476, Umm Al Sahik, Safwa 31941- Kingdom of Saudi Arabia
has been assessed and found to be in accordance with the requirements of
standard detailed below

ISO 9001:2015

This Certificate is valid for the following scope
Provide (Civil, Electrical & Mechanical) Services Related to Construction and Maintenance of Buildings,
Roads, Water & Sewage System & Industrial Facilities, Design & Installation of Scaffolding Systems
in Public and Industrial Sector, Provide Services of Industrial Blasting & Coating System,
Trading and Rental of Heavy & Earth Moving Equipment's
(IAF Group -28 & 29)

Initial Registration Date	21 st Jan. 2017	Current Issue Date	13 th Feb. 2023
1 st Surveillance on or before	21 st Dec. 2023	Valid Until	20 th Jan. 2024
2 nd Surveillance on or before	21 st Dec. 2024	Revision	00
		Issue no.	03

Certification Cycle of this certificate is three (3) years from the issue date and validity of the certificate shall be subject to the successfully completion of the surveillance audit as mentioned above, current status of the certificate can be verified on
i.e. www.isoindia.org & www.iafcertsearch.org

Pragyesh Singh
TNV Certification Pvt Ltd
CIN: U74900UP2011PTC046719
Accredited by United Accreditation Foundation (UAF)

Accreditation Board Add: United Accreditation Foundation Inc, 400 North Center Dr Ste 202, Norfolk, Va 23502, United States of America

Certification Body Add. H.O.: TNV House, 537-B/187-B Amber Vihar, Lucknow-20, India. Mail: info@isoindia.org

*Validity of the certificate is subject to continued compliance of the management system standard and successful completion of audit as planned by TNV from time to time. Further clarification regarding the scope of this certificate and the applicability of standard may be obtained by consulting the organisation. This certificate remains property of the TNV and must be returned on request. For surveillance details, please visit at www.isoindia.org. Registered Office: TNV House, 537-B/187-B Amber Vihar, Lucknow-20, UP, India.



Certificate of Registration

Certificate No: 190212026621

This is to Certify that the Environment Management System of
Nassir S. Al Hyder and Partner Company For General Contracting
P.O Box 476, Umm Al Sahik, Safwa 31941 - Kingdom of Saudi Arabia
has been assessed and found to be in accordance with the requirements of
standard detailed below
ISO 14001:2015
This Certificate is valid for the following scope
"Provide (Civil, Electrical & Mechanical) Services Related to Construction and Maintenance of Buildings,
Roads, Water & Sewage System & Industrial Facilities, Design & Installation of Scaffolding Systems
in Public and Industrial Sector, Provide Services of Industrial Blasting & Coating System,
Trading and Rental of Heavy & Earth Moving Equipment's"
(IAF Group- 28 & 29)

Initial Registration Date	12 th Feb. 2019	Current Issue Date	13 th Feb. 2023
1 st Surveillance on or before	Completed	Valid Until	11 th Feb. 2024
2 nd Surveillance on or before	12 th Jan. 2024	Issue No.	02
		Revision	01

Certification Cycle of this certificate is three (3) years from the issue date and validity of the certificate shall be subject to the successfully completion of the surveillance audit as mentioned above, current status of the certificate can be verified on
i.e. www.isoindia.org & www.iafcertsearch.org



CB-MS-2206



MEMBER OF MULTILATERAL
RECOGNITION ARRANGEMENT



Pragyesh Singh
TNV Certification Pvt Ltd
CIN: U74900UP2011PTC046719
Accredited by United Accreditation
Foundation (UAF)

Accreditation Board Add: United Accreditation Foundation Inc, 400 North Center Dr Ste 202, Norfolk, Va 23502, United States of America

Certification Body Add. H.O.: TNV House, 537-B/187-B Amber Vihar, Lucknow-20, India. Mail: info@isoindia.org

*Validity of the certificate is subject to continued compliance of the management system standard and successful completion of audit as planned by TNV from time to time. Further clarification regarding the scope of this certificate and the applicability of standard may be obtained by consulting the organisation. This certificate remains property of the TNV and must be returned on request. For surveillance details, please visit at www.isoindia.org. Registered Office: TNV House, 537-B/187-B Amber Vihar, Lucknow-20, UP, India.

NASSACO JV PARTNERS

[CJI General Services \(Electricity, mechanical, infrastructure development, industrial services and construction\)](#)

[CJI specializes in conceptual engineering, procurement, fabrication, construction and maintenance business.](#)

Activities extend to all aspects of the general contracting business including:

- Scaffolding works implementation of projects rent and sale
- Electricity works Supply and Install, remove, replace, modify and maintain HV AND LV overhead and underground distribution networks up to 36 KV
- All kinds of electrical cables tested
- Power solution solar energysystemsSupply and Install, remove, replace, modify and maintain
- Sandblasting and painting (Storage tank cleaning, repairs and painting)
- Insulation and cladding Supply and Install, remove, replace, modify and maintain (asbestos and non-asbestos)
- Fabrication and erection of steel structures (structural and pipes) andPipeline, pump, valves, instrumentation
- Skilled manpower supply
- Fibre Optic networks worksSupply and Install, remove, replace, modify and maintain
- INSTRUMENTATION, AUTOMATION AND SCADA
- Implementation of the work of the Telecommunications Supply and Install, remove, replace, modify and maintain
- Information Technology Networks Enterprise Software Development Web design Security monitoring systems
- Design Engineering
- Civil works services (i.e. bridge and road repairs, duct Bank, tank bund wall repairs and erection)
- Building Construction and maintenance
- Carrying out water, sewage and rainwater network works. Supply, installation, removal, replacement, modification and maintenance of water
- Security fencing grille Supply and Install, remove, replace, modify and maintain
- Heavy and Light equipment rental
- Networks, surveillance cameras and ERP programs Supply and Install, remove, replace
- Procurement and industrial supplies
- Concrete structure preparation, repair and grouting
- GRP pipe laying and fibreglass and lamination
- Heat exchanger fabrication and re-tubing
- Mechanical repairs and constructions
- Pre-qualification of skilled workers
- Mechanically precise dismantlement, preservation and packaging of equipment for re-use
- Provision of technical expertise on refinery dismantling-equipment preparation, safe handling, dismantling procedures, cost and timelines
- Mechanical equipment and instruments repair

NASSACO CONSULTANT PARTNERS

Plexus (Instrumentation/SCADA) - Portugal

PLEXUS' core activity is industrial systems' integration



ELECTRICITY

We calculate, design and build low voltage electrical cabinets



INSTRUMENTATION

We select the right measuring principle for the intended application and supply the adequate instruments



VALVE ACTUATION

We select actuators according to needed binary and operation time and we supply the MOVs ready to operate

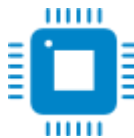

AUTOMATION

We develop PLC and HMI/SCADA software to automate processes, increasing safety and productivity



LOADING SYSTEMS

We are national leaders in loading systems for liquid combustibles



STOCK CONTROL

Our software controls product from several stockholders inside the same tank



ACCESS CONTROL

Biometric, ANPR (automatic number plate recognition), RFID, traffic lights and barriers



DATA NETWORKS

We design and implement Ethernet, FO and wireless industrial communication networks



SYSTEM INTEGRATION

We integrate subsystems so that they work together as one and only in a transparent way to the operator



MAINTENANCE CONTRACTS

We provide preventive and corrective assistance 24/7/365



REMOTE ASSISTANCE

We make use of the most modern technologies to provide remote assistance, reducing costs and reaction time



ENERGY EFFICIENCY

We design and install energy saving systems according to the customer consumption profile

NASSACO JV PARTNERS

Scaffolding works implementation of projects rent and sale



Nassaco's Industrial Scaffolding provides work access solutions, including design, supply, and sales

Nassaco's Industrial Scaffolding provides work access solutions, including design, supply, sales, rental, erecting and dismantling scaffolding services to oil and gas, petrochemical, power plants and process industries,

Because many other crafts depend on scaffolding, our work is often the foundation for successful industrial projects. That's one reason we hold ourselves to the highest standards for training and strive to optimize our performance at every level...

We stock thousands of tons of different types of scaffolding materials and accessories that can be constructed in all different styles including:



External boiler scaffolds Pre-engineered systems for large or complex projects



External System scaffolds System scaffolds Birdcage internal scaffolds



NASSACO JV PARTNERS

Electricity works

Electricity works Supply and Install, remove, replace, modify and maintain HV AND LV overhead and underground distribution networks

Nassaco is an approved SAUDI ELECTRICITY COMPANY (SEC) active contractor which has the capability to approach all projects in an experienced and confident manner, delivering a high quality electrical system installation services to the clients.

Nassaco is an ISO 9001:2015 certified company and is firmly implementing quality management systems and continually improve and maintain its standards of excellence.

Electrical Systems is a full-service solution for any and all electrical problems and emergencies. With a full crew of qualified industry professionals, we have engineers and technicians to promptly analyse and eliminate any electrical problems that the Industrial and Commercial world may face in day-to-day operations, and we are available 24-7 to handle emergencies.

Overhead Transmission Projects



We maintain the highest standards of service, while providing comprehensive design, management and construction on Overhead Transmission projects, regardless of size or complexity. Our resources include, but are not limited to:

Install, remove, replace, modify and maintain

- Experience with all operating voltages
- Application of lattice tower, steel, laminate and wood pole construction

Under Ground Projects.



There are a variety of installations that require underground electrical work to be performed. Trenching or boring are the two most common methods used for underground electrical installations. Determining whether to use trenching or boring usually will depend upon the terrain and cost factors of the job. For example, if the electrical installation is under a parking lot, or in a heavily treed area, boring might be the method of choice. However, on open land, trenching might be the method of choice.

Grid Station Projects.



An electrical grid is an interconnected network for delivering electricity from producers to consumers. It consists of. Generating stations that produce electrical power. High voltage transmission lines that carry power from distant sources to demand centres. Distribution lines that connect individual customers.

Consumer Projects.



A consumer unit is a type of distribution board (a component of an electrical power system within which an electrical power feed provides supply to subsidiary circuits).

Testing Electrical Measurements

Battery Testing Equipment Cable Testing Cable tracer and fault locator Circuit Breaker Test Clamp Meters DMM Earth Testers Electrical Testers Energy meter measurement Field Calibrator High Voltage testers HV lines and switchgears equipment Installation Testers/ PAT testers Insulation Testers Low Resistance Testers LV earthing systems LV Live working tools LV test and measurement Medium voltage equipment MV Substation equipment Oil test Over head Line test equipment Partial Discharge Testers Portable Analogy Meters Power Quality Relay Testing Scope meter Thermal Imagers Thermometers Transformer Testing

Power solution

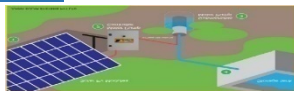

- Solar power generation has emerged as one of the fastest growing sources of renewable energy. Solar power generation has many advantages:
- Low dependence on fossil fuels, solar energy production does not require fossil fuels, and is therefore less dependent on this limited and costly natural resource, relying on a natural source that is constantly available.
- *Environmental benefits solar energy production generates electricity with limited impact on the environment as compared to other forms of electricity production*
- The solar power plant can be installed at the client's site, which reduces the cost of Constructing a space for the installation of the solar plant.

Sandblasting and painting

INDUSTRIAL FABRICATION, BLASTING & PAINTING SERVICES:



A professional company with integrity and knowledge; specializing in the surface preparation and application of coatings. With a large modern workshop near Um AL-Sahik, we are fully equipped to handle all of your abrasive blasting and spray painting needs.

We use the finest quality raw materials to ensure that you get the finish and the durability in the field that you expect. Only top quality materials are used. Paint is supplied by market leaders.

Application of protective coatings is in accordance with International Standards and the inspection of finished products is carried out as per the guidelines.

As surface preparation and protective coatings application are carried out, we ensure to reduce the time between blasting and coating application as per industry norms. This is well within the recommendation in most paint specification, thus preserving the integrity of the blast.

NASSACO's ABRASIVE BLASTING & PROTECTIVE COATINGS are meant for long-term corrosion protection.

ENGINEERING, DESIGN & PROJECT MANAGEMENT SERVICES:

NASSACO and JV partners CJI, MARS offers engineering, fabrication/construction services for industrial facilities such as:

- Oil & Gas
- Chemical and Petrochemical Plants
- Desalination Plants
- Power Plants
- Process Industries

Our Engineering and Design department ensure the customization of design to fit the unique requirements for each client. This will ensure the cost-efficient performance of projects and timely completion.

INSTRUMENTATION, AUTOMATION AND SCADA

Measuring and controlling the process variables is a meticulous business. Perfecting those abilities within a production, laboratory or manufacturing arena is a fine art, one that requires specialized instrumentation and automation (I&A) products and services.

Relevant excels in specialized I&A control for a wide range of conditions, including, but not limited to, temperature, pressure, level and flow, precision custody transfer, process automation, remote communication and full-scale DCS solutions. In the most critical of times, relevant platform and our diverse product line out perform.



Instrumentation



Process Controls & Systems



Wireless



Valves & Regulators



Heat Trace



Gas & Fire Systems



Analytical & Analytics



Accessories



Combustion

INDUSTRIAL INSULATION SERVICES:



Nassaco, is specialized in full-service insulation in petrochemical, chemical, petroleum refining, ethanol, fertilizer, industrial, and manufacturing projects and provides service to construction locations.

We cater to the ethanol and petrochemical industry by providing complete insulation services of piping, equipment, vessels, tanks, and ducting systems.

Our highly experienced and talented Project Managers oversee every facet of each project - quality control, labour, schedule, and cost - ensuring you a superior result.

Our services include:

- Insulation & Lagging for Piping and Ductwork
- Removable Insulation
- Tank Insulation
- Equipment Insulation

PIPE REPAIR SERVICES



Nassaco with JV partners' expertise provides specialized pipe repair services for major petrochemical, oil and gas projects.

Our Piping Team are highly skilled to execute pipe rehabilitation works, excavation, dewatering, Pipe Sleeving, welding, sandblasting, coating.

Our services include:

Mechanical Piping, Steel Fabrication and Installation, Pipe Repair (Sleeving), Leak Sealing

SKILLED MANPOWER SUPPLY SERVICES:



We offer highly trained and certified industrial manpower hire services of various trades for the execution of projects in oil & gas, petrochemical, power plants and process industries.

Over the years, our selective hiring process and active recruiting methods from our partners produced incredible team of overachievers that can handle complex task of our client's manpower requirements and to execute exceptional performance in our clients' ongoing projects. We had employed and mobilized since then, more than 1,000 skilled craft workers and salaried individuals for our projects and clients across the kingdom.

NASSACO understands that each Client is unique and has special needs. Our flexibility allows us to create an arrangement which incorporates the various aspects of our different services. This in turn allows us to customize the service to better respond to the Client's particular requirements. Professionals in their respective field of discipline ranging from Office Administration and Support Services up to the execution of jobs in the site. Trained Engineers and Technician are capable of accomplishing your requirements efficiently.

Engineering Manpower:

- Piping Supervisor
- Piping QC
- Civil Engineers
- Civil Supervisors
- Site Foreman
- Civil Works Labourer
- Mechanical Engineers
- Mechanical Supervisors
- Mechanical QC
- Safety Manager
- Safety Officer
- Riggers
- Mechanical Labourer
- Electrical Engineer
- QA/QC Engineers
(All Disciplines)

- Electrical Foreman
- Electricians

Welding Manpower:

- Welding Inspector
- Welders

Scaffolding Manpower:

Estimation Manpower:

- Estimation Engineers

Sandblasting Manpower:

- Sandblasting Supervisor
- Sandblasting Crew

Coating Manpower:

- Coating Supervisor
- Coating applicator

Computer Aided Design (CAD) Manpower:

- Design Engineers
- AutoCAD Operators

Plumbing Manpower:

- Plumbing Engineer
- Plumbing Supervisor
- Plumber

Non-Destructive Testing (NDT):

- NDT Specialist
- NDT Technicians

- Certified with acceptable license in the industry
- Properly trained & experience in scaffolding
- Scaffold Crew
- Scaffold Foreman
- Scaffold Supervisor
- Scaffold Inspector
- Safety Officers
- Site In-Charge
- Project Engineers

Fibber Optic Telecom Manpower:

- Site Engineer
- Project Engineer
- Safety Officers
- Network Engineer
- Fibber Optic Technicians
- Network Technicians
- Cabling Technicians
- Telecom Technicians
- OSP Fibber Splicer Technicians
- OSP/ISP field Engineer
- Fibber Optic Construction Labourers
- Structured Cable Technicians

Insulation Manpower:

- Industrial piping Insulators
- Fabricators
- Tin man
- Machine operators
- Multi-layer insulation technicians

Administration Manpower:

- Executive Secretary
- Project Management
- Administrative Assistants
- Secretary / Clerks

Telecommunications

Nassaco is an approved SAUDI TELECOM COMPANY (STC) active contractor which has the capability to approach all projects in an experienced and confident manner, delivering a high-quality telecommunication works especially Optical Fibber installation services to the clients.

Nassaco is an [ISO 9001:2015](#) certified company and is firmly implementing quality management systems and continually improve and maintain its standards of excellence. Inspection and test procedures are carried out by experienced, skilled operatives, using test instruments which are regularly checked for calibration by an approved certified company.

Fibber-optic communication is a method of transmitting information from one place to another by sending pulses of light through an optical fibre. The light forms an electromagnetic carrier wave that is modulated to carry information. Fibber is preferred over electrical cabling when high bandwidth, long distance, or immunity to electromagnetic interference is required.

Optical fibre is used by many telecommunications companies to transmit telephone signals, Internet communication, and cable television signals.

Modern fiber-optic communication systems generally include an optical transmitter to convert an electrical signal into an optical signal to send into the optical fiber, a cable containing bundles of multiple optical fibers that is routed through underground conduits and buildings, multiple kinds of amplifiers, and an optical receiver to recover the signal as an electrical signal. The information transmitted is typically digital information generated by computers and telephone systems.

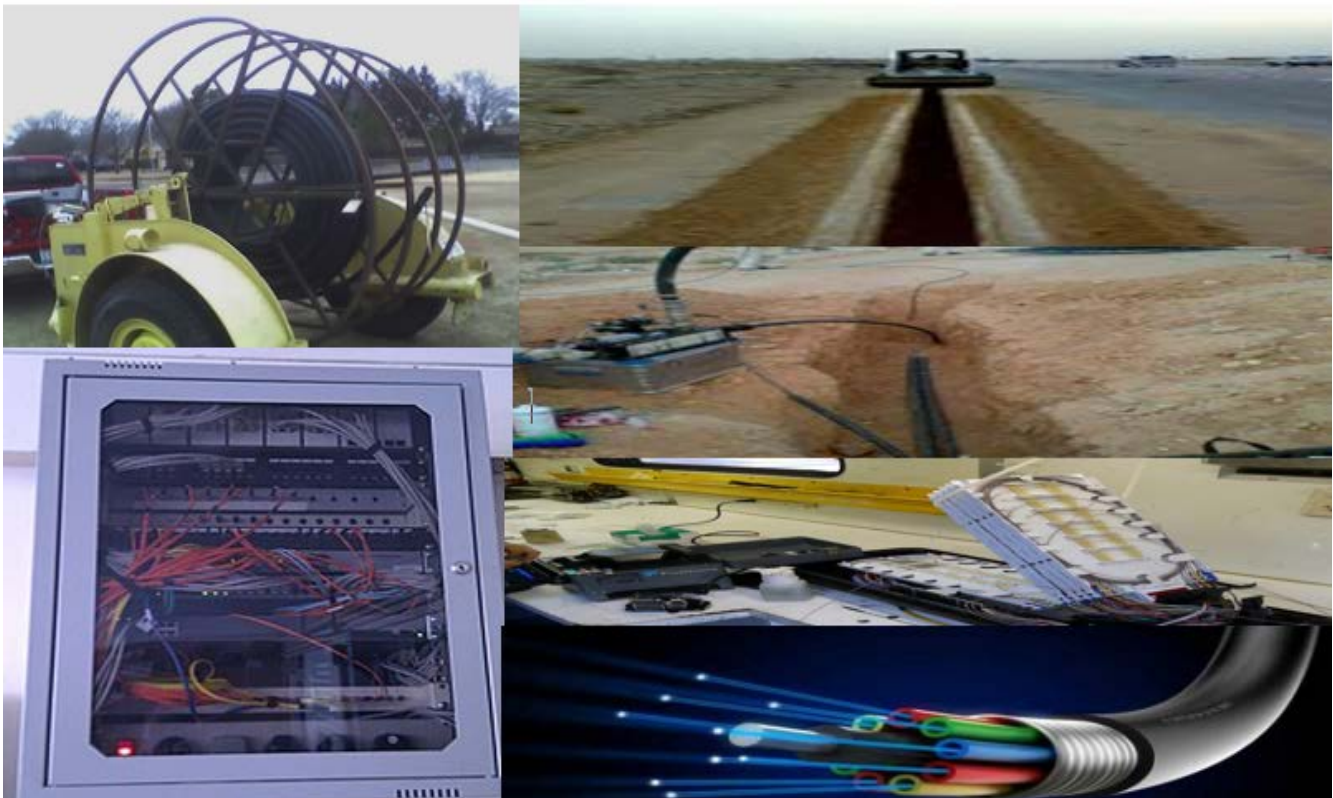

Civil Structural Design Services

Involve our expertise in flawlessly handling of Civil, Residential, Commercial, Industrial and other projects.

Features:

- Services handled by experienced team of professionals
- Experienced team support working towards providing clients professional and innovative service solutions

Specifications:

- Services comprising site visits, concept design & development, liaising with architects & builders/contractors
- Services aimed at ensuring co-ordinate and smooth running of projects
- Rich engineering experience allowing us to offer cost competitive solutions
- Meeting the Commercial, Industrial and Residential structural design needs
- Expertise in providing structural analysis and design solutions for broad range of structures
- Experience in working on large number of architectural/industrial projects
- Also offering solutions for renovation alteration and addition
- Making use of latest software support to provide for easy-to-interpret structural drawings
- Expertise in offering creative solutions as per the needs of clients

Civil Works Service

Civil work Services is backed by having with us in-depth understanding of civil work solutions.

Features:

- Combined with experienced team of professionals we successfully render civil construction services to clients
- Following stringent norms to offer best quality services at reasonable prices

Specifications:

- Expertise in undertaking execution of civil structural construction works at different stages
- In-depth knowledge of handling work areas like erection of form-work, steelwork, concreting and others
- Also handling the solution demands for foundations, substructures, super structures
- Expertise in offering solutions exactly as per laid down and approved specifications
- Competitively priced solutions

RCC Work

Reinforced Cement Concrete solutions offered are backed by our rich experience in handling RCC tasks for large span structures, Running Plant Industries, Residential & Commercial Buildings

Features:

- Expertise in handling work support for RCC structures
- Service support of experienced professionals

Specifications:

- Can successfully handle projects of varied size and complexity levels
- Can provide for different structural systems like conventional beams, waffle slabs, steel beams, trusses and others
- All conceptualization done keeping in mind related safety, practicality factors
- Expertise in undertaking structural analysis using proven software support
- Keeping in mind factors like seismic loads, wind loads and others while offering services
- All solutions delivered come closely reviewed to ensure high accuracy and quality

Earth Excavation Services

Descriptions:

We render our clients with earth excavation services, which include cutting out a section for a building, digging all footings and removal of fill off site. These services find application in the projects related to construction of buildings and projects for drainage systems. In these services, directional boring and vacuum excavation are used virtually on all the projects that include site utility construction, communications and demolition constructions.

Land Planning

We provide planning support to clients and institutions for land use applications and entitlement projects. Our services include:

- Project design and development
- Preparation of Master Plans
- Conceptual, Preliminary and Final Project design
- Site Planning
- Subdivision design and layout
- Lot, road and infrastructure layout
- Federal, state and local permit processing
- Entitlement representation and processing
- Subdivision (single family, multi-family, commercial, and mixed use)
- Project Planning Consultation
- Cost Analysis
- Project presentation at public hearings

Surveying

BISCO provides our clients with the surveying edge throughout the project cycle by combining traditional surveying techniques with advanced surveying technology. Our surveying crews are equipped with state of the art Real Time Kinematic (RTK), Global Positioning System (GPS) technology, and conventional equipment for data collection. Professional staff and the latest in technology enable us to provide increased productivity and innovative solutions for clients.

Our services include:

- Construction Staking and Building Layout
- Digital Leveling
- Boundary Surveys
- Lot Surveys
- Topographical Mapping
- Subdivision (single family, multi-family, commercial)
- Site Planning and Layout
- Aerial Mapping Ground Control
- Computer Aided Design (CADD)
- Global Positioning Systems (GPS) Static networks
- GPS – Real time stakeout and data collection
- As Built Mapping
- Condominium Mapping
- Improvements Surveys
- Utility and Route Surveys
- ALTA/ACSM Land Title Surveys
- Section and Township Surveys
- Project Planning Consultation
- Reconnaissance Surveys
- Soundings and Flow Profiles

Civil Engineering

Our services include:

- Grading & Drainage Studies & Plans
PE on a site visit during construction
- Individual Sewage Disposal System Designs (ISDS)
- Surface Water Hydrology Studies
- Storm drainage collection and treatment systems
- Computer Aided Design and Drafting (CADD)
- Construction Plans, Specifications and Documentation
- Feasibility Studies
- Road and Transportation System Designs
- Utility Layout and Design
- Highway Access Plans
- Earthwork Take-Off and Balance Calculations
- Construction Observation & Administration Cost Analysis

▪ GENERAL CIVIL WORKS:



Nassaco experts gained a unique experience on many general civil projects, which lead to customer benefits as risks minimization, easy solving of complex and non-standard engineering problems, highest quality of works and competitive prices.

The company has all necessary licenses and certificates to run civil works in Saudi Arabia, this allows us to fulfil the most parts of civil works independently, with the minimum help from subcontractors.

Nassaco projects management system complies with [ISO 9001:2015](#).

Nassaco executes housing projects thru joint-ventures with multinational construction companies:



Our role of General Contractor includes excellent logistics for equipment and materials to get them on site and many other General Contractor activities to run projects in-time and Smoothly.

Roads and blueprints



Nassaco is one of the leading companies in the field of general contracting, asphalt works and road construction in particular. We have carried out many asphalt asphalting projects and the entrances to factories and companies in various parts of the kingdom

As well as infrastructure works and equipping residential and industrial plans with its various floors, as well as the work of railway tracks

Carrying out water, sewage and rainwater network



Nassaco Contracting Co. is one of the distinguished companies in the field of maintenance and implementation of water networks, ground and upper tanks, water transmission lines, pumping stations, buildings, dams, landscaping and site organization.

Security fencing grille Supply and Install, remove, replace, modify



Nassaco has the best expertise to implement governmental and private agricultural and security networks, at the highest standards, and with high professional engineering supervision

EARTHMOVING EQUIPMENT SUPPLY SERVICES:



Nassaco provides equipment rental solutions for customers in every major construction sector, as well as the industrial, energy and manufacturing industries. Regardless of the size of your job, we forge a partnership to make you our best customer.

With one of the youngest fleets in the industry, you can count on us to deliver the fast, safe and reliable rental experience.

Every Nassaco customer is connected to a committed sales representative, who understands your business, answers the phone when you call, and is empowered to deliver for you. You'll also have access to a support centre and a seasoned service team, who rigorously maintain the equipment you need from the brands you trust.

Stocked with everything from aerial lifts, material handling forklifts, earthmoving equipment, compaction machines and other general rental items - Nassaco is in your backyard and is your partner for building success.

INDUSTRIAL EQUIPMENT RENTAL SERVICES:



Main products in our rental fleet include rental of generators, compressors, tower lights, welding machines, forklifts, roller compactors, power systems, access systems, dewatering pumps, portable units.

We offer rental equipment rental solutions for various projects and industrial sectors – Oil & Gas, Construction, Mining, Marine, EPC, Power, Petrochemical, Infrastructure, Utilities to name a few.

Supported by a team of highly trained & dedicated professionals, we offer total integrated rental solutions, offering quality products & services to nearly all major industrial sectors.

Information Technology

Networks

Nassaco IT works on designing and implementing computer networks, internet houses, villas, smart offices and home automation system and communications for companies and small and medium enterprises as well as major companies in all governorates of the of The kingdom in addition to its work as network management and provide technical support and focus on preventive maintenance and reduce Malfunctions occur under annual contracts.

The company helps support your business with technical support for computers, information and technology supplies for your company, maintenance of computer networks, the Internet, and e-mail requirements.

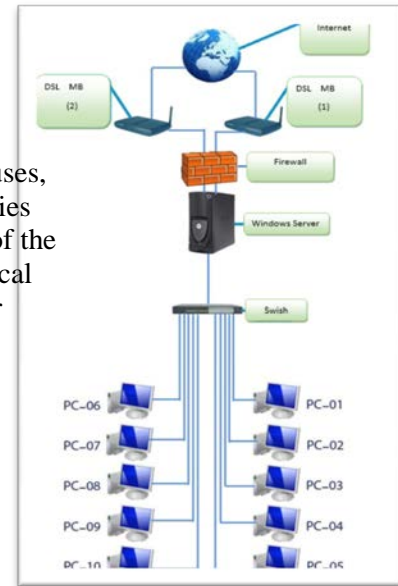

Enterprise Software Development

Our ERP developers deal with complex implementation projects, including third-party solutions and legacy applications that may become an obstacle during the integration process. Our engineers are experienced in developing custom ERP systems and integrating them with any other business systems like CRM, Supplier, Order & Purchase systems, HR & Payroll management systems, Inventory management, etc.

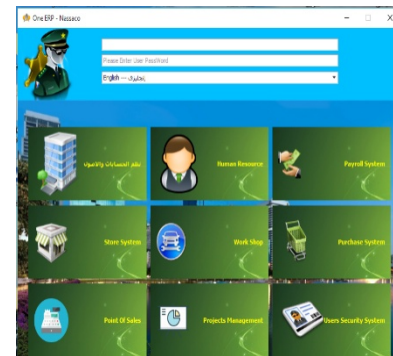

Web design

The Nassaco web design service company provides individuals, companies agencies that seek to distinguish through a sophisticated interface on the Internet, we do not only provide web design service, but integrated solutions and distinct identity using the latest technologies in line with search engines, internet browsers and smart devices in accordance with international standards In design and programming

Security monitoring systems

The company aims to provide the latest security monitoring systems in the world, where we supply and install all types of surveillance cameras in all places, residential, companies, hangars and major stores, and our vision is summarized in the following points:

Providing the latest surveillance systems in the world.

Providing professional services in this field.

Providing the best offers and prices.



Safety MATERIALS:



The core mission of Nassaco's Safety materials supply division is to help safety managers build an enduring culture of safety that minimizes injuries and maintains a more protective and productive workplace.

Nassaco offers head-to-toe personal protective equipment to help you keep your business compliant and your employee's safe, saving you time and reducing costs.

We are committed to providing our customers with the kind of PPE safety that instills confidence when they leave for work in the morning, knowing our quality equipment means one less safety risk they'll have to endure throughout the day.

The hazards addressed by protective equipment include physical, electrical, heat, chemicals, biohazards, and airborne particulate matter.

FACILITIES AND RESOURCES

Office / Workshops /Warehouses / Lay down Yard / Workers Camp

LOCATION: UMM AL SAHEQ – JUBAIL – DAMMAM HIGHWAY (NEAR RASTANURA EXIT)

CAPACITY:

Total capacity 321,502m² (Various Plots)

Worker camp-1:5,500 m²

Covered Warehouse-1: 4000 m²

Covered Warehouse-2: 4200 m²

Covered Warehouse-3: 4200 m²

Various workshops: 7000 m²

DEPARTMENTS / FACILITIES:

- HR &ADMIN
- PROJECTS
- OPERATIONS
- ENGINEERING
- ESTIMATION
- SALES & MARKETING
- FINANCE & ACCOUNTS
- PROCUREMENT
- FABRICATION
- INFORMATION TECHNOLOGY
- SUPPORT SERVICES
- TRAINING
- CONFERENCE AREA
- CAFETERIA

OTHERS:

- PROJECT OFFICE
- WAREHOUSE OFFICE
- FABRICATION WORKSHOP
- VEHICLE WORKSHOP
- VEHICLE SERVICE STATION
- E & I WORKSHOP
- PRECAST WORKSHOP
- PAINTING & SAND BLASTING WORKSHOP
- NDT AREA
- MATERIAL LAYDOWN YARD
- WORKERS CAMP
- MESS HALL
- PRAYER ROOM
- PLAY GROUND

Workshops /Warehouses / Lay down Yard / Workers Camp

LOCATION: AL AHSA

CAPACITY:

Worker camp-2:4,500 m²

Covered Warehouse-4: 4000 m²

Covered Warehouse-5: 4950 m²

Various workshops: 5500 m²

FACILITIES:

- PROJECT OFFICE
- WAREHOUSE OFFICE
- FABRICATION WORKSHOP
- E & I WORKSHOP
- VEHICLE WORKSHOP
- VEHICLE SERVICE STATION
- PRECAST WORKSHOP
- PAINTING & SAND BLASTING WORKSHOP
- NDT AREA
- MATERIAL LAYDOWN YARD
- WORKERS CAMP
- MESS HALL
- PRAYER ROOM

Staff Accommodations:

LOCATION: RASTANURA 2ND INDUSTRIAL CITY

STAFF ACCOMMODATION-1: AREA: 4250 m²

FACILITIES:

- STAFFACCOMMODATION
- RECREATION HALL
- COMMON KITCHEN
- MESS HALL
- PRAYER ROOM

STAFF ACCOMMODATION-2: AREA: 3200 m²

LOCATION: RASTANURA - RAHIMA

FACILITIES:

- STAFFACCOMMODATION
- RECREATION HALL
- COMMON KITCHEN
- MESS HALL
- PRAYER ROOM

LOCATION MAP-1 –Umm Al Sahek - Corporate Head office - Workshops /Warehouses / Lay down Yard / Workers Camp

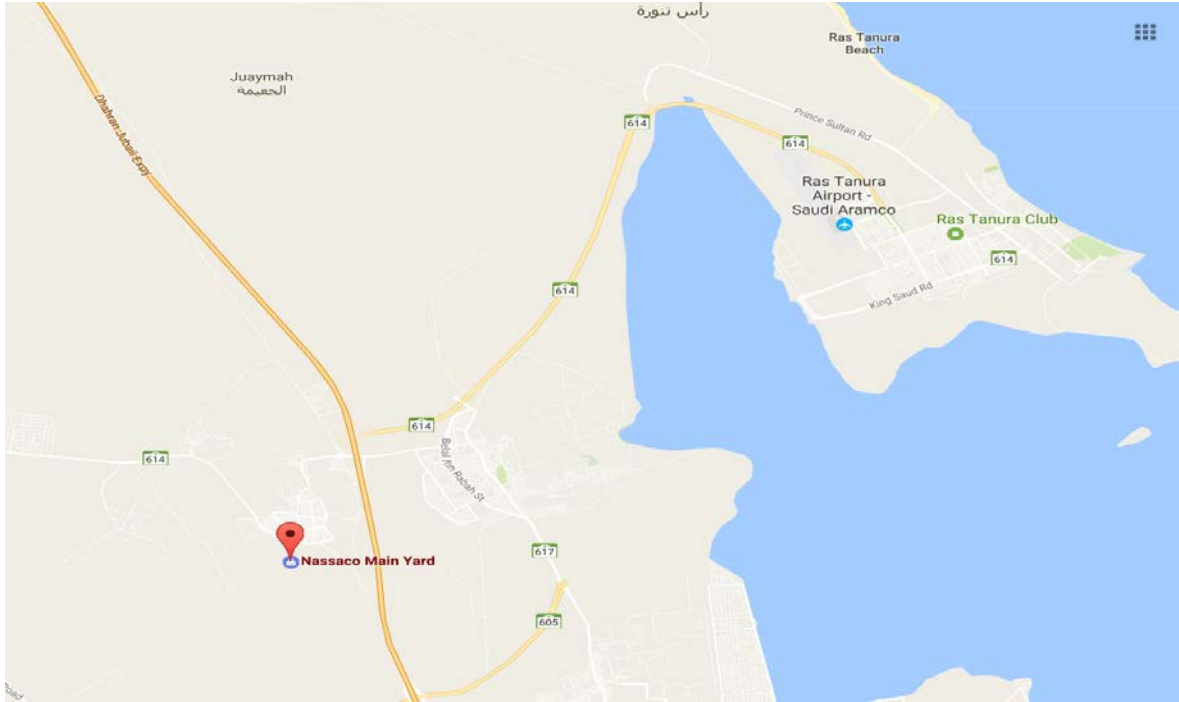

LOCATION MAP-2 – Al Ahasa - Workshops /Warehouses / Lay down Yard / Workers Camp

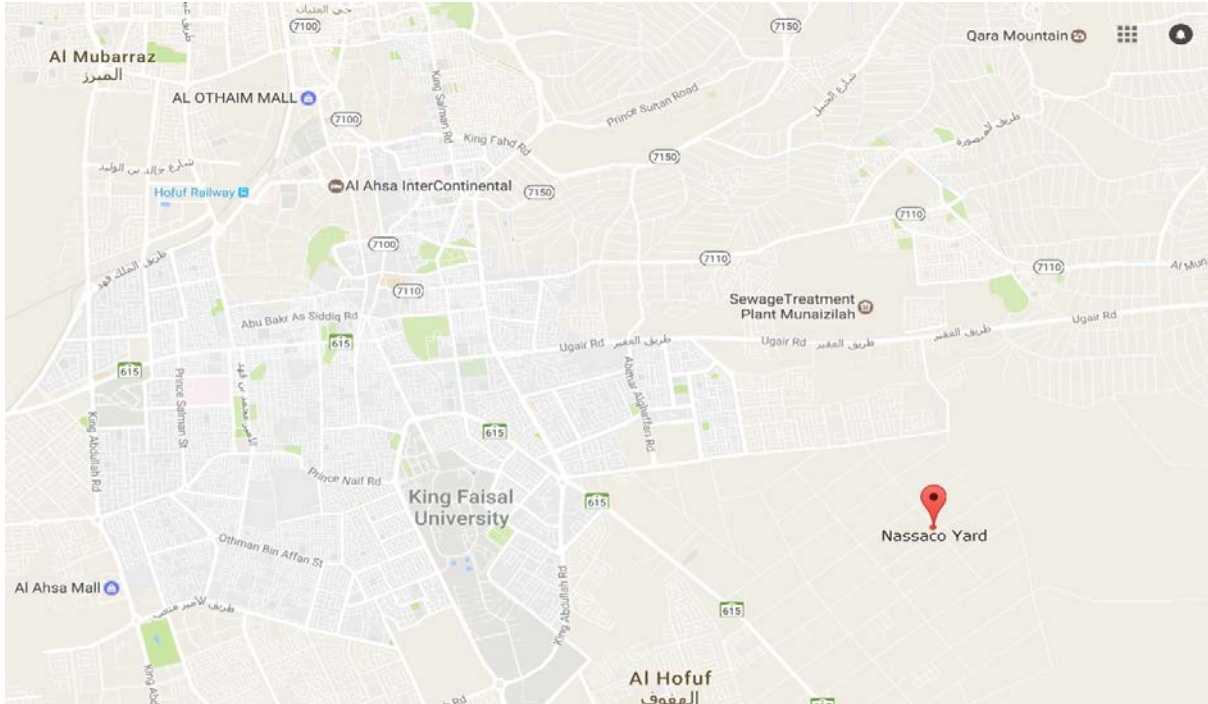

Vehicles / Equipment / Machineries / Devices

VEHICLES

S. No.	Description	Quantity
1.	BUS	08
2.	SEDAN CARS	40
3.	SUVs	21
4.	4 X 4 HILUX PICKUP	38
5.	DYNA	22
6.	DUMP TRUCKS	28
7.	BOOM TRUCKS	16
8.	TRAILERS	24

EQUIPMENT

S. No.	Description	Quantity
1.	BOBCAT – HIGH HYDRAULIC FLOW	18
2.	BOBCAT WHEEL SAW (TRENCHERS)	04
3.	BOOM CRANES	18
4.	FORKLIFTS (7 TONS)	09
5.	FORKLIFTS (10 TONS)	07
6.	MANLIFT	12
7.	CRANES	02
8.	BACKHOE LOADER	34
9.	EXCAVATORS	25
10.	LOADERS	24
11.	ROLLER COMPACTOR	25
12.	JUMPING COMPACTOR	25
13.	PLATE COMPACTOR	25

MACHINERIES

S. No.	Description	Quantity
1.	REBAR CUTTING MACHINE	05
2.	REBAR BENDING MACHINE	05
3.	WOOD CUTTERS	08
4.	WELDING MACHINE	22
5.	DRILL MACHINE (50 MM)	40
6.	DRILL MACHINE (20 MM)	40
7.	LATHE MACHINE	03
8.	CABLE HYDRAULIC CRIMPING MACHINES	18
9.	CABLE CUTTERS	40
10.	CABLE PULLING MACHINES	06
11.	CABLE RULERS	12
12.	CABLE REEL STAND	15
13.	COMPLETE TOOLS FOR OVERHEAD LINES	10
14.	PIPE BENDING MACHINE	05
15.	PIPE CUTTING MACHINE	05
16.	COMPRESSORS (750 CFM)	14
17.	COMPRESSORS (400 CFM)	12
18.	COMPRESSORS (300 CFM)	12
19.	COMPRESSORS (175 CFM)	15
20.	TOWER LIGHTS 300 KVA	28
21.	GENERATOR 400 KVA	25
22.	BLASTING POTS	40
23.	AIR RECEIVING TANKS	40
24.	AIRLESS SPRAY PAINTERS	40
25.	ROLLING MACHINE (INSULATION)	03
26.	FOLDING MACHINE (INSULATION)	02
27.	SHEET CUTTING MACHINE (INSULATION)	03
28.	GROOVING MACHINE (INSULATION)	06
29.	LOCKING MACHINE (INSULATION)	03

DEVICES

S. No.	Description	Quantity
1.	HOLIDAY DETECTOR	11
2.	CABLE FAULT LOCATOR METER	04
3.	GLOBAL POSITIONING SYSTEM (GPS)	25
4.	AUTOMATIC LEVEL	10
5.	JEEP VOLT METER	07
6.	TOUCH PYROMETER	05
7.	REAL HUMIDITY DPM	06
8.	DIAL FILM THICKNESS GAUGE	06
9.	SURFACE PROFILE GAUGE	08
10.	WHIRLING HYGROMETER	09
11.	WET FILM THICKNESS COMB GAUGE	09
12.	DEW POINT METER	07
13.	ULTRASONIC THICKNESS GAUGE	03
14.	AIR RECEIVER MANIFOLD	35
15.	HART COMMUNICATOR	08
16.	THERMAL LABELLING SYSTEM	04
17.	INSULATION TESTER	07
18.	SWEEP FUNCTION GENERATOR	06
19.	FREQUENCY SIGNAL GENERATOR	04
20.	THREADING MACHINE	08
21.	CONDUIT BENDER	14
22.	FLUKE METERS (VARIOUS)	19
23.	TOOL KIT	35
24.	TORQUE WRENCH	40
25.	TORQUE MULTI PLIER	15
26.	PRESSURE GAUGE	56
27.	PRESSURE RECORDER, PUMP, HT	37
28.	DEAD WEIGHT TESTER	08
29.	SAFETY RELIEF VALVE	19
30.	HYDROTEST MANIFOLD	06

MANPOWER

DESCRIPTION	DESIGNATION	NOS.	
SKILLED TECHNICIANS	INSULATORS	75	
	FABRICATORS	5	
	TIN-SMITH	60	
	MACHINE OPERATORS	40	
	ELECTRICAL TECHNICIANS	10	
	INSTRUMENT TECHNICIANS	5	
	BLASTERS & PAINTERS	5	
	SCAFFOLDERS	185	
	SCAFFOLDING HELPERS	50	
	FIBER OPTIC TECHNICIANS	5	
	TELECOM NETWORK ENGINEERS	2	
	MASONS	5	
	CARPENTERS	5	
	SKILLED HELPERS	19	
	GENERAL PLUMBERS	4	
	HEAVY DRIVERS	20	
	HEAVY EQUIPMENT OPERATORS	38	
	QC & SAFETY	QC SUPERVISOR – CIVIL	12
		QC SUPERVISOR –MECHANICAL & WELDING	2
		QC INSULATION, PAINTING & COATING	2
QC INSPECTOR – CIVIL		1	
QC INSPECTOR - WELDING		2	
SAFETY SUPERVISOR, OFFICERS		4	
WPR		4	
FOREMEN	FOREMAN – CIVIL	16	
	FOREMAN – ELECTRICAL	14	
	FOREMAN – MECHANICAL & PIPING	4	
	FOREMAN – SCAFFOLDING	7	
	FOREMAN – INSULATION	2	
	FOREMAN – PAINTING & COATING	3	
PROJECT MANAGEMENT	PROJECT MANAGERS	8	
	QUALITY ASSURANCE MANAGER	1	
	QUALITY CONTROL MANAGERS	1	
	SAFETY MANAGERS	3	
	PROJECT OFFICE SUPPORT STAFF	15	
ENGINEERS	CIVIL ENGINEERS	2	

DESCRIPTION	DESIGNATION	NOS.
	INSULATION ENGINEERS	3
	ESTIMATION ENGINEERS	2
	STRUCTURAL ENGINEERS	2
	PLANNING ENGINEERS	2
SUPERVISORS	SUPERVISORS- SCAFFOLDING	7
	INSPECTOR -SCAFFOLDING	2
	SURVEYORS - CIVIL	2
	SUPERVISOR - MECHANICAL	2
	SUPERVISORS – CIVIL	2
	SUPERVISORS – ELECTRICAL	5
OFFICE ADMINISTRATION	MANAGERS	6
	SECRETARIES	6
	MARKETING SPECIALISTS	5
	DOCUMENT CONTROL	2
	GOVERNMENT RELATIONS OFFICERS	2
	TOTAL	474

AVAILABLE WORKING VISAS: 425 VISAS

REFERENCE PROJECTS completed and On-going

S. No.	Contractor Clients	Type of Services Provided	Location	Project Name
1	Saudi Electricity Company	Electric Works	Northern Area	Unified Contract Northern Area
2	Saudi Electricity Company	Electric Works	Dammam	Unified Contract 2020 for Dammam
3	Saudi Electricity Company	Electric Works	Al Hasa	Unified Contract For Al Hasa
4	Al-Hakmia Housing Company	Electric Works	Dammam	Al Hakmia Housing – Low Voltage
5	Al-Hakimiya Housing Company	Electrical	Dammam	Eskan Housing Prtject
6	General Police Security	Additional & Improvement of Aqir Police Station Building	Aqir – Al Hasa	Additional & Improvement of Aqir Police Station Building
7	Saudi Electricity Company	Electric Works	Al Hasa	Electricity works Supply and install, remove, replace, modify and maintain HV AND LV overhead and underground distribution networks up to 36 KV
8	Sendan International Co. Ltd.	Scaffolding Services	Jubail	Scaffolding Work With Sabic Plant & Aramco Plant
9	Saline Water Conversion Corporation(SWCC)	Scaffolding Services	Jubail	Scaffolding Work With SWCC Jubail Project
10	Baker Hughes Saudi Arabia Operation @Maintenance	Scaffolding Services	Dammam/Khobar	Scaffolding Berti Project HP unit 1106649, Erection and dismantling Project: S100029
11	Bluemart Trading Co.	Scaffolding Services	Jubail	Scaffolding Materials Rental to Marjan Project
12	Reza-Gulf Scaffolding Co. Ltd.	Scaffolding Services	Hawaiya	Scaffolding Services ARCC - Hawaiya
13	Babcock Borsig Service Arabia Ltd (Bilfinger)	Scaffolding Services	Ghazian	Ghazian Project
14	Yapi Merkezi (Package 10)	Electrics/ Civil works	Jubail Port	Saudi Railway Project
15	Yapi Merkezi (Package 5)	Civil works	Jubail Port	Saudi Railway Project
16	Yapi Merkezi (Package 1&2)	Electrical	Jubail Port	Saudi Railway
17	Yapi Merkezi (Package 6)	Civil works	Jubail Port	Saudi Railway
18	Yapi Merkezi (Package 9)	Electrical	Jubail Port	Saudi Railways
19	Basic Chemical Industry (BCI)	Blazing & Painting	Dammam	Petrochemical Plants
20	Branch of WISON Engineering Ltd	Scaffolding Services	Ras tanura	Propane Ras Tanura
21	EPPM - Tunisian Saudi for Projects Co. Ltd.	Scaffolding Services	Al Khobar	Ju'aima Tank Farm Facilities for AH Delivery
22	Saudi Electricity Company	Scaffolding Works	Eastern Province	Electricity works Supply and install, remove, replace, modify and maintain HV AND LV overhead and underground distribution networks up to 36 KV

REFERENCE PROJECTS completed and On-going

No.	Client	Project Description	Location	Services	Contract Value
23	Saudi Electricity Company	Electricity works Supply and install, remove, replace, modify and maintain HV AND LV overhead and underground distribution networks up to 36 KV	Dammam/Qatif	Electric Works	
24	AVTB	P.19993- Cons. Operations Mgmt.	Jubail	Scaffolding Services	
25	General Police Security	Security Addition & Fortification of Public Security Training City	Meccah	Security Addition & Fortification of Public Security Training City	
26	General Police Security	Maintenance of one area state security	Meccah	Maintenance of one area state security	
27	General Police Security	Construction of store building for national guard	Meccah	Construction of store building for national guard	
28	General Police Security	Construction of store building for state security	Meccah	Construction of store building for state security	
29	Mohammed Hassan Almuzain & Partners Co. For Industrial Services	SASREF	Jubail	Scaffolding Services	
30	Yapi Merkezi (Package 12)	Saudi Railway Project	Jubail Port	Electrical/ Civil works	
31	Karrens Arabia Co., Ltd	YCC Project	Dammam	Scaffolding Services	
32	Enppi Kingdom of Saudi Arabia	Abqaiq Recovery Plant	Abqaiq	Scaffolding Services	
33	Salem Al Salem Cont. Est.	Civil Construction of SWRC Project	Khobar	Blasting & Painting	
34	BEMCO Steel Industries Co. Ltd	SAIPEM Manifa Project	Manifa	Scaffolding Services	
35	Contracting and Construction Enterprises	Khurais Project P174 (SAIPEM)	Khurais	Blasting & Painting	
36	JACR Company For Petroleum & Industrial Services	SAFCO 2 Ammonia Plant	Jubail	Scaffolding Services	
37	Enppi Kingdom of Saudi Arabia	Abqaiq Recovery Plant	Abqaiq	Scaffolding Services	
38	Nawaf Mattar Al-Adwani & Partner Cont. Co. Ltd	Fadhili Gas Plant	Fadhili	Blasting & Painting	
39	Expertise Contracting Co. Ltd	SASREF	Jubail	Scaffolding Services	
40	BEMCO Steel Industries Co. Ltd	Qurayyah Power Plant	Qurayyah	Blasting & Painting	
41	Rotary	SAMREF	Yanbu	Scaffolding Services	
42	Petroleum, Chemical and Mining Company Ltd. (PCMC)	Fadhili Gas Project	Fadhili	Scaffolding Services	
43	Advanced Construction Method Est	Sab Tank	Jubail Port	Scaffolding Services	
44	ANABEEB	SASREF	Jubail	Scaffolding Services	
45	Shams Mohsen Al-Marzouq Est.	Cogeneration Interconnection Facilities	Ras Tanurah	Scaffolding Services	
46	Al-Fanar Company	SCECO Power Station	Dammam	Scaffolding Services	
47	MASS International Cont. Co. Ltd.	SIPCHEM	Jubail	Scaffolding Services	
48	Reas-Gulf Scaffolding Co. Ltd.	Ithra Cultural Center	Dhahran	Scaffolding Services	
49	Petroleum, Chemical and Mining Company Ltd. (PCMC)	MAADEN Phosphate	Ras Al Ithair	Scaffolding Services	
50	Al Ruzaid Construction Co. Ltd	Cogeneration Interconnection Facilities	Ras Tanurah	Blasting & Painting	
51	Arabian Fa Limited Company	Refinery	Ras Tanurah	Blasting & Painting	

REFERENCE PROJECTS completed and On-going

	Maritime Industrial Services Arabia Ltd.	Blasting & Painting/ Scaffolding Services	Hawiya	Aramco Rig ADC 33
52				
53	Saudi Fal Ltd	Scaffolding Services	Jubail	ALBAYRONI Cogeneration Interconnection Facilities
54	H.K Al Saeiq Sons Contracting Co. Ltd.	Scaffolding Services	Juaymah	Jazan Refinery & Terminal Project
55	Nasser S. Al-Hajri Corp.	Blasting & Painting	Jizan	Aramco Housing
56	Al Obayan Trading & Contracting Est	Blasting & Painting	Dhahran	SADARA
57	Saudi Arabian Mentz Co. Ltd	Blasting & Painting	Jubail	Wasit Gas Plant (Pckg #4)
58	Branch of SK Engineering of Construction Co. Ltd	Assistance of Scaffolding Works	Wasit	Ghazlan Project
59	Power Equipment & Materials Co. Ltd.	Blasting & Painting/ Scaffolding Services	Ghazlan	SADARA
60	Larsen & Toubro Atco Saudi	Scaffolding Services	Jubail	Riyadh Refinery
61	Olayan Descon	Blasting & Painting	Riyadh	Maaden Aluminum
62	Saudi Arabian Mentz Co. Ltd	Scaffolding Services	Jubail	Khursaniyah Gas Plant
63	METSCO	Blasting & Painting	Khursaniyah	Maaden Aluminum
64	Petron	Scaffolding Services	Maaden	Low Density Polyethylene Project Saudi Kayan
65	SINOPEC	Scaffolding Services	Jubail	Qurayyah Power Plant
66	Arabian Bemco	Blasting & Painting	Qurayyah	Early Need Tanks
67	Petro Steel	Blasting & Painting	Saudi Kayan	Early Need Tanks
68	Petro Steel	Scaffolding Services	Saudi Kayan	Later Need Tanks
69	Petro Steel	Scaffolding Services	Saudi Kayan	Later Need Tanks
70	Petro Steel	Scaffolding Services	Saudi Kayan	Later Need Tanks

A sample of certificates received from our clients



NASSIR S. ALHYDER & PARTNER CO.
For Contracting

A Nassaco Group C.R.2063605934



**شركة ناصر سالم الحيدر وشريكة
للمقاولات العامة**

إحدى شركات مجموعة نساكو س . ت . 2063605934

For more information

Please visit our website at

www.nassaco.com